

COACHING PRINCIPLES	2
WARM UP / ACTIVITIES	
Horse and Jockey	4
Rugby Octopus	5
Rob the Nest	6
Paddo's Drill	7
Tag Ball	8
FIELDING THE BALL	
Roll and Carry	9
Placing Relay	10
Pick Up and Place	11
HANDLING / PASSING DRILLS	
Give and Go	13
Triangle Drill	15
Semi Circle Pass Race	16
Pick Up and Pass	17
Poor Passes	19
Under and Over Relay	20
Captain Ball	21
Sprint and Pop (Formally Relay 1)	22
Captain Ball Rounders	23
Diagonal Passing	24
Circle the Wagon	25
Hot Potato	26
RUNNING / EVASION	
Step and Swerve	27
Out and Back	28
DESIGNER GAMES	
Rugby Baseball (Passing and Kicking)	29
Rugby Tennis (Passing and Kicking)	31

- a) As coach of a team you are responsible for many aspects of the individuals development including their skills, both individual and team: improving a players fitness levels and enjoyment and most importantly, encouraging individuals to play within the laws in a safe environment.

OBJECTIVES OF THE COACHING SESSION

- Fun
- Maximum activity
- As many touches on the football as possible during the session

To achieve the above goals careful planning is required, with the following to be considered:

- Simple, easily organised activities at the start of the session with the aim of warming up the students, and creating a situation where they are more likely to listen, should be the major aim.
- Activities which build from smaller numbers, to larger group work, should be planned with pairs easily being formed early, with teams etc being formed from these groupings.
- Equipment should provide for at least one ball between three students to increase their participation and activity level.

GROUP ORGANISATION

Communication Checklist

- All players close & paying attention
- All equipment down (out of hands)
- Short concise explanations
- Voice variation (stress important points)
- Sun not in the eyes of class

SKILLS COACHING

Only give players small amounts of information. Children especially will quickly lose interest if large amounts of information are given at one time. Sequence for coaching should follow these guidelines:

- 1) Set-up and briefly explain drill
- 2) Let players attempt drill several times
- 3) Discuss technique faults as a group
- 4) Continue drill with individual fault correction.

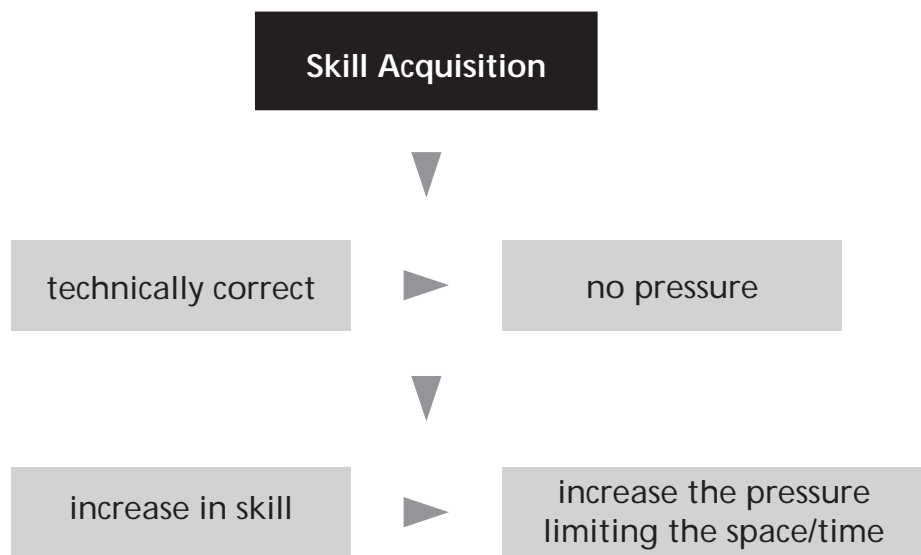

GROUP ORGANISATION/MANAGEMENT

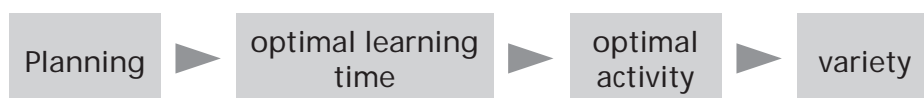

Drills Checklist

- Planned (do they work)
- Relevant (to skill level of group)
- Correcting common faults
- Maximise participation/learning
- Enjoyable
- Flow from one to the next
- Fitness component.

STRETCHING

Fun and simple to organise games should begin the training session.

Quickly move into an activity and keep discussion to a minimum early.

Stop periodically during session for stretching and then give any team information etc in small amounts. (players will listen and be less distracted if they are recovering from moderate activity).

1. Raise the body temperature and blood flow around the body.
2. Stretch main muscle group (during the time). Stretching needs to be done before and after a training session (perfect times are warm-up and wrap-up. While your talking get the players to stretch) (see attachment 1#).

MODIFIED GAMES - WARM-UP

I HORSE AND JOCKEY

- Equipment: One ball between two.
- Area: 20 x 20m
- Grouping: Pairs (of equal size)

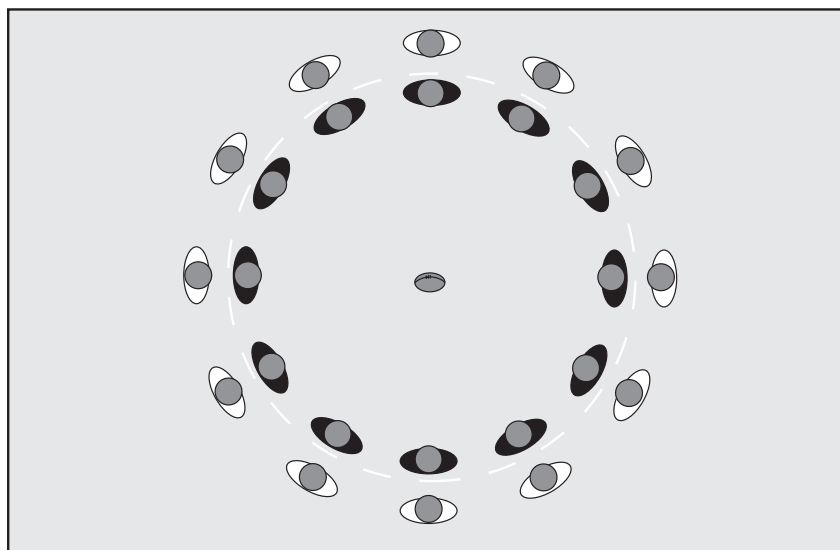

Description

In pairs in two circles with one partner (the horse) on the inside of the circle facing in, and the other partner on the outside (the jockey) facing the back of the horse.

On the command of "mount your horses" the jockeys mounts the horse (piggy back).

On the command of "left" or "right" the jockeys dismount and run around the circle in the direction indicated by the command. (only the jockeys run).

A turn each without the ball is recommended, then the ball can be used to perform skills (ie around the body, through the legs, around the head etc) as the players are running around the circle.

The stationary horses can also be used as markers with the players dodging in and out between the horses as they go around the circle.

Helpful Hints:

Begin the coaching session with Horse and Jockey and use the time between turns to stretch and/or talk to the players. You will find the group is easier to keep quiet as they wait in anticipation for their turn. (Lower your voice and ask for quiet before each new turn).

II RUGBY OCTOPUS

- Equipment: Markers x 4
- Area: 25 x 40m
- Grouping: One group 2 – 3 Taggers

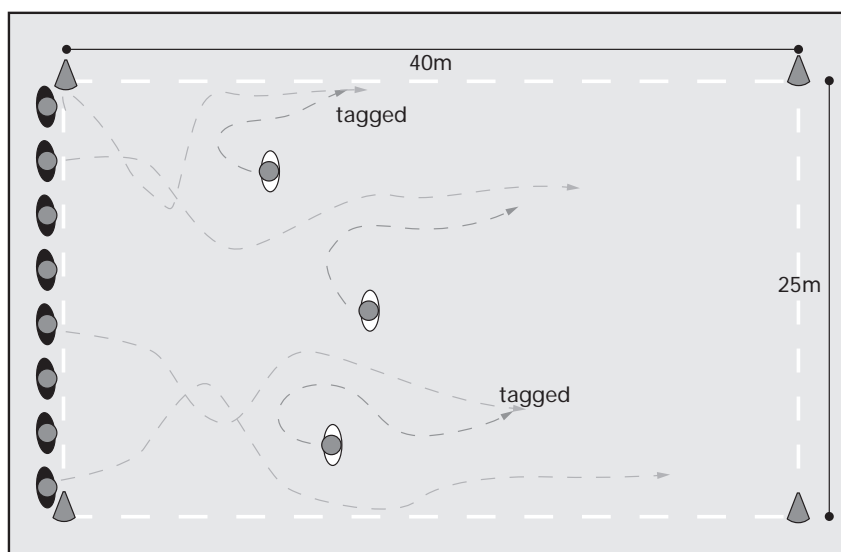

Description:

A group up along one side of the grid and 2-3 "master taggers" are in the middle of the grid. On the coaches call the group sets out across the grid in an attempt to get to the other side. The "master taggers" must try to tag these runners with two hands. When tagged the runners drop down on their knees and become "assistant taggers", they cannot move around but may tag runners with just one hand. This repeats with each crossing until only 2-3 runners are left. They then become the "master taggers" for the next game.

Should the call of "rugby octopus" be used to start the runners a coach may add to the fun by calling "Go" or "Octopus" with any runners leaving, becoming instant assistant taggers.

Helpful Hints:

Increase the number of taggers at the start if dealing with a large group.

III ROB THE NEST

- Equipment: 4 – 6 balls placed in the middle of grid
- Area: 20 x 20m (corners marked)
- Grouping: 3 – 5 each corner

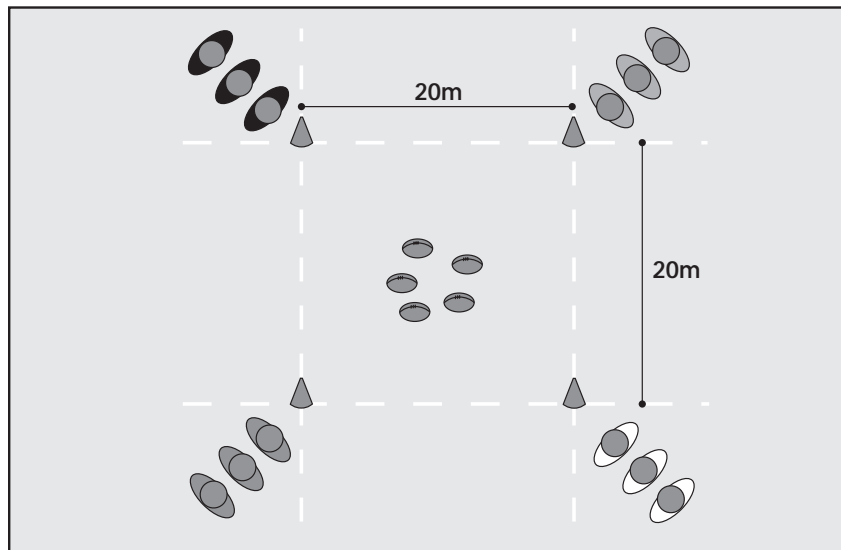
**Description**

The overall object of the game is to get as many balls from the centre of the grid back to your own "nest" or corner.

On the "go" command one player from each line attempts to get a ball from the middle and place them back in their own nest.

They then tag the next player in the line who then attempts to retrieve more balls.

Only one ball can be carried at a time, and the ball must be placed in the "nest" not thrown.

When the balls are gone from the centre, players may steal from each others nest, with the team not allowed to protect their own nest.

The first team with 3 balls back at their nest is the winner.

Helpful Hints:

The coach can hold another 1-2 balls back and throw them in the centre to hasten results.

Variation: Run only one player per group until a winner is found, then next player can have a turn.

IV PADDO'S DRILL

- Equipment: witches hats/ball per group
- Area: Defined area depending on the size of the group. (keep area confined as possible)
- Grouping: 2-3 per group

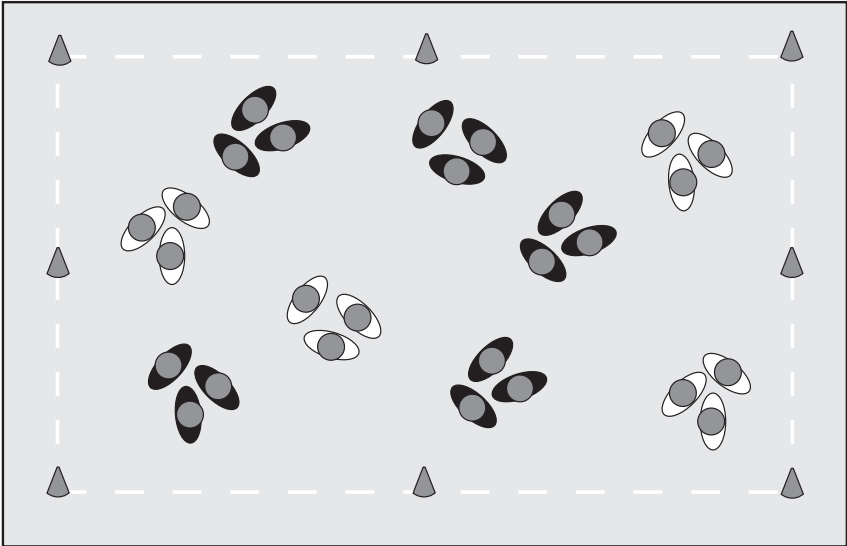

The basis of the activity is the group reacting to a series of numbers called and performing specific skills on each number, within the grid.

- No 1 = Group passing to each other moving around the grid.
- No 2 = Place pick-up, One player places the ball in a certain area within the grid, next picks up the ball and places the ball elsewhere and so-on.
- No 3 = Circle ball around the body throw in the air, next player catches it and repeats.
- No 4 = Players must tag their opponents with the ball then place the ball on the ground, with next player picking up the ball and endeavouring to tag someone else.
- No 5 = Think up as many possible variations as possible or students think up their own.

V) TAG BALL (ONE / TWO ROVING) (NZ RUGBY M)

- Equipment: Ball per group
- Area: Grid pattern
- Grouping: No more than 12 players per grid

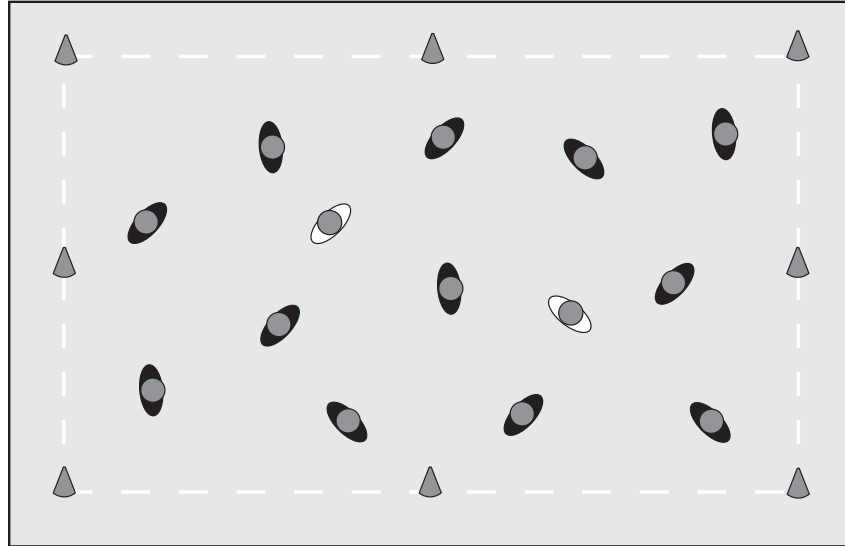

Description:

One player is nominated as a runner. The other members of the group must attempt to tag the runner with the ball by passing it amongst their team and tagging the runner whilst holding the ball. Once in possession of the ball you cannot run.

Variations:

Divide into two teams with a tagging team and a running team.

ROLL + CARRY

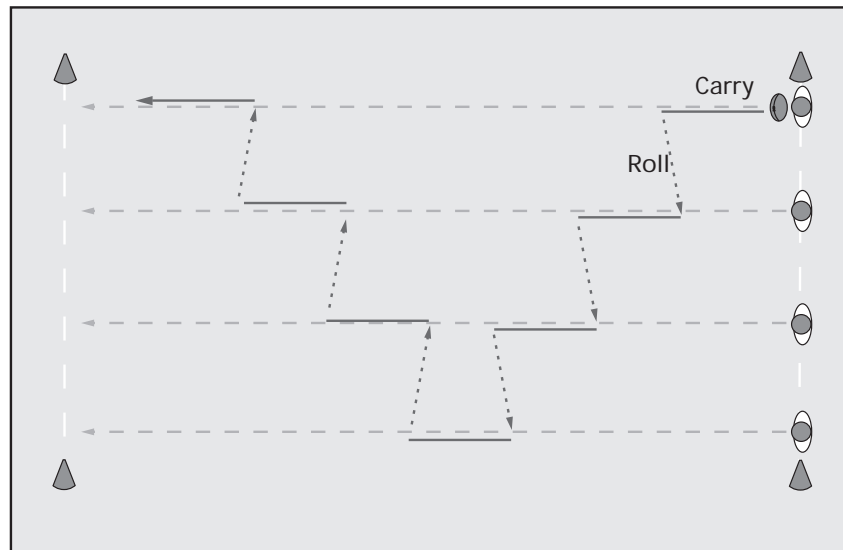

Equipment: 1 ball per group

Grid Size:

Group Size: 4 – 5

Drill Description:

All players take off together.

Player A runs 10m with the ball and then rolls it to player B who runs and rolls it to player C and so on.

Variation:

Players form 2 groups. The groups line up in single file with the front players separated by a distance of at least 10m. A relay is set up where the ball is rolled out in front of players from the group opposite.

Helpful Hints:

- Players should pick up ball from side on with both hands.
- Players should run in a slightly crouched position with ball in 2 hands.
- Players should lower their bodies well before the pickup – don't "bob down" at the last instant!
- Players should call "my pickup" when picking up the ball.
- Players should bend the knees to pick up ball.
- Players should remain low and accelerate after the pickup.

PLACING – RELAY

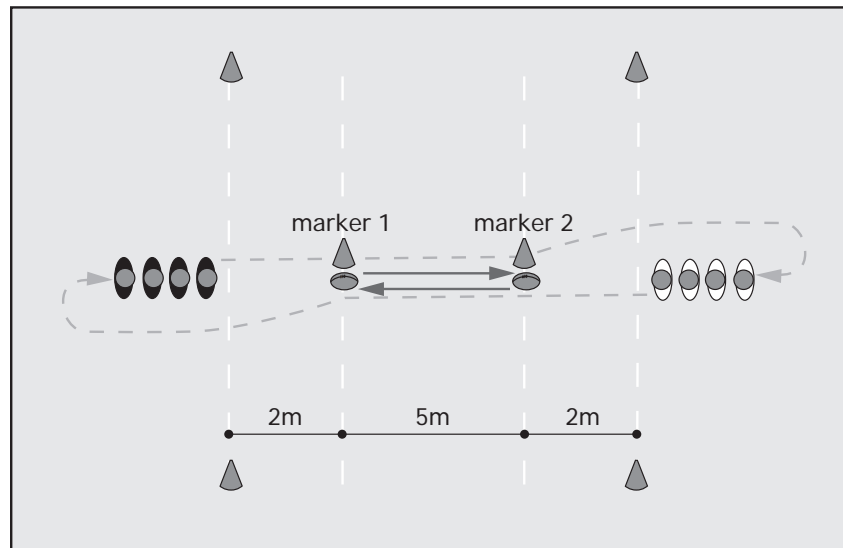

Equipment: 2 balls per group

Grid Size: 15 x 15m

Group Size: 10 v 10

Drill Description:

2 groups face each other in a line as shown.

A ball is placed at a marker 2m in front of each group. The front player in Line 1 picks up the ball from Marker 1, places it on Marker 2 and runs behind Line 2.

The front player in Line 2 picks up the ball from Marker 2 and places it on Marker 1 and runs behind Line 1 and so on.

Helpful Hints:

- i) The drill works best in the form of a relay with 2 teams competing against each other.
 - With elementary exercises of this type, maximum benefit always comes from competition between groups. Players at all levels like to win and remember there always has to be a loser and as they say, losing is good for the soul!
 - Stay low on approach to the ball.
 - Place the back foot closest to the ball, bend knees and sweep through with back hand to pick it up.
 - Call "my pick" stay low and accelerate away.
 - Pick up ball from side on.
 - Practice picking up from both sides and practice placing on both sides.
 - Don't let the ball drop or bounce and call "ball down" when placing.

PICK UP & PLACE

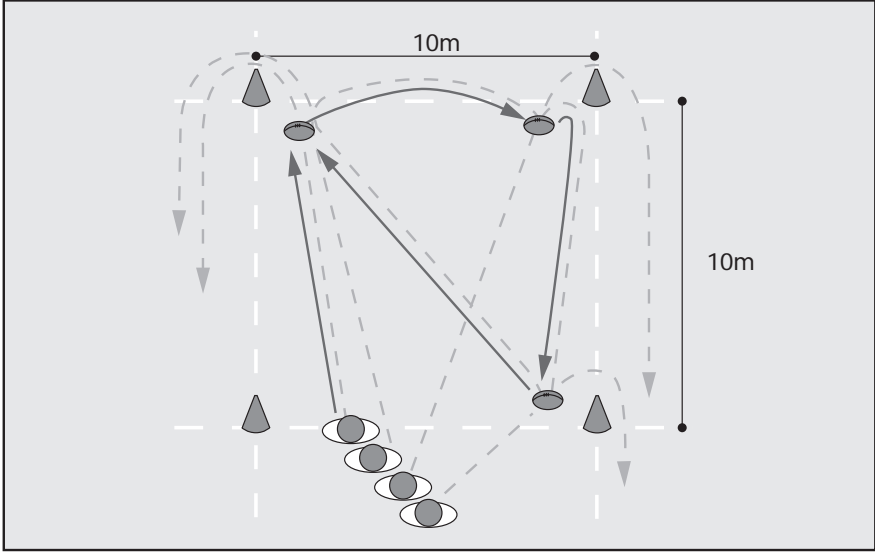

- Equipment: 5 – 8 balls
- Suitability: Primary School +
- Grid Size: 10m x 10m min.
- Group Size: 4+

Drill Description:

Players line up in a group outside and at one corner of a grid, the ball being with the front player.

On the signal from the coach the front player runs into the grid, randomly places the ball on the ground and returns to the back of the group by exiting the grid at the nearest point then running around its perimeter.

As soon as the ball is placed the second player sprints to the ball, picks it up on the run and also randomly places it within the grid boundaries before rerunning to the group as earlier described. The drill continues.

Variations:

- i) If more players available, divide them up into 2 more groups and position them at other corners of the grid. All groups perform the exercise as above, creating more traffic in the grid square.
- ii) Have players enter the grid in pairs. The leading player has the ball and runs randomly around the grid with abrupt direction changes with the aim being to lose the follower. When the ball carrier places the ball the follower must pick it up as soon as possible (on the run) and pass it back to the next pair waiting at the corner.
- iii) Have the follower dive on the ball using the baseball slide.

Helpful Hints:

- With elementary exercises of this type, maximum benefit always comes from competition between groups. Players at all levels like to win and remember there always has to be a loser and as they say, losing is good for the soul!
- Players should approach from alongside the ball so as not to kick or fall over it. The back foot should be placed behind the ball.
- When picking up the ball, ensure players bend at the knees.
- Less skilful players should pick up the ball with 2 hands – spread the fingers and scoop the ball with the nearest hand in behind the ball and the other clamping it from the front immediately after.

GIVE & GO

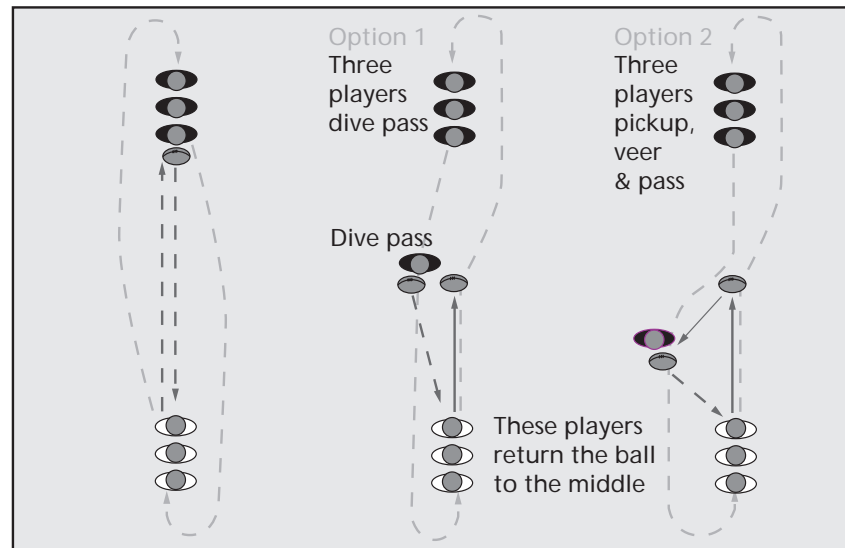

Equipment: 1 ball per group

Grid Size: NA

Group Size: 6+

Drill Description:

Players should form into 2 lines facing each other. The player with the ball executes a pop pass to the first player in the opposite line then runs to the end of the opposite line and so on.

Variation / Extension:

- i) The ball is placed on the ground between each line. The front player runs to the ball, executes a dive pass, gets up and runs to the rear of the opposite line. Player receiving puts the ball down between lines and runs to rear of opposite line. Therefore every second player will be passing with the receiver placing.
- ii) The ball is again placed on the ground between each line. The first player advances to the ball, picks it up on the run veers to the left or right and passes to the front player in the other line. The player now in possession accelerates hard and places the ball back on the spot where it was initially placed and continues through to the back of the opposite line.

Helpful Hints:

When picking up the ball:-

- i) The rear foot should be near the ball and the leading foot should point towards the target.
- ii) The receiver should have his hands up to receive the ball.
- iii) For the second variation described, the coach may wish to stand near the middle and as the player advances to pick up the ball he signals by holding out an arm which way the player should veer. Have the players change direction with a sidestep etc.

TRIANGLE DRILL

Equipment: 2 balls per group
Grid Size: 10 x 5m
Group Size: 5

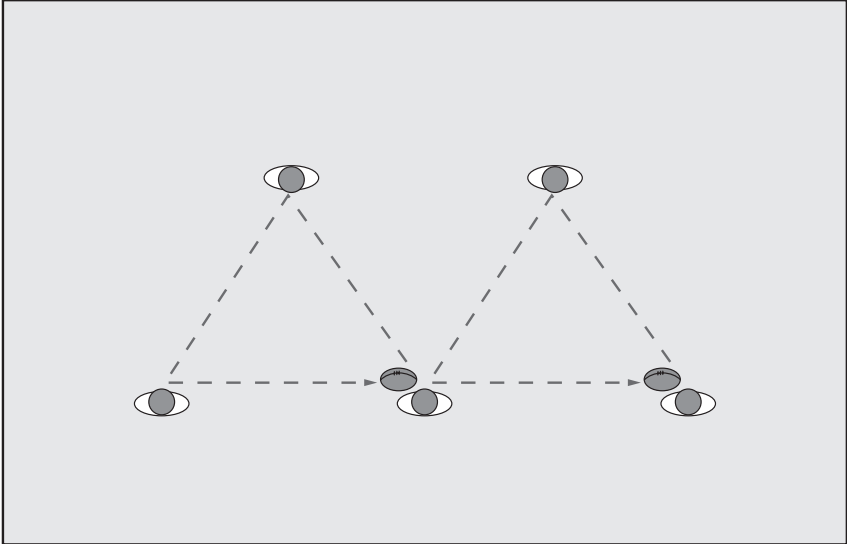

Drill Description:

Five players form 2 triangles with the centre player being part of both as shown.
Two balls are passed along the lines of both triangles as shown.
The aim is to complete as many circuits as possible without dropping the ball.

Variations:

- i) Pressure can be added by competing against time or against another group.
- ii) Introduce another player and make one of the triangles a square. This upsets the rhythm of the exercise and makes the centre player have to concentrate a bit harder.

Helpful Hints:

- Players should not pass to another player if that player is not expecting a pass
- As soon as a player has passed the ball that player should be alert for the next .
- Players should try to be aware where both balls are.

SEMI CIRCLE PASS RACE

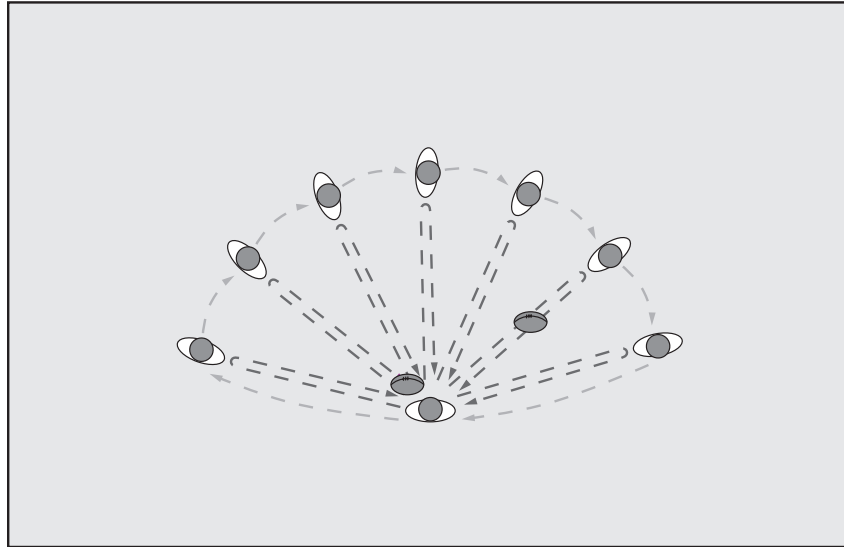

Equipment: 1 ball per group

Suitability: Primary School +

Grid Size: NA

Group Size: 5 – 8

Drill Description:

A group of players fan out in a semi-circle in front of a Player A with the ball.

Player A passes back and forth to each player in turn in the semi-circle. On reaching the end that player moves to replace Player A while he moves to the end of the line.

Variation:

Use 2 balls. Players should not pass the second ball too early. The player now remains in the middle for a set time.

Helpful Hints:

- All players must get their hands out to receive and not let the passes come to their chests.
- Passes should be made to the target i.e. the hands.
- After catching and passing, players must immediately focus on the second ball.
- Balls should not be slapped back. They must be caught before returning.
- Passes should be made from both strong and weak sides.

PICK UP & PASS

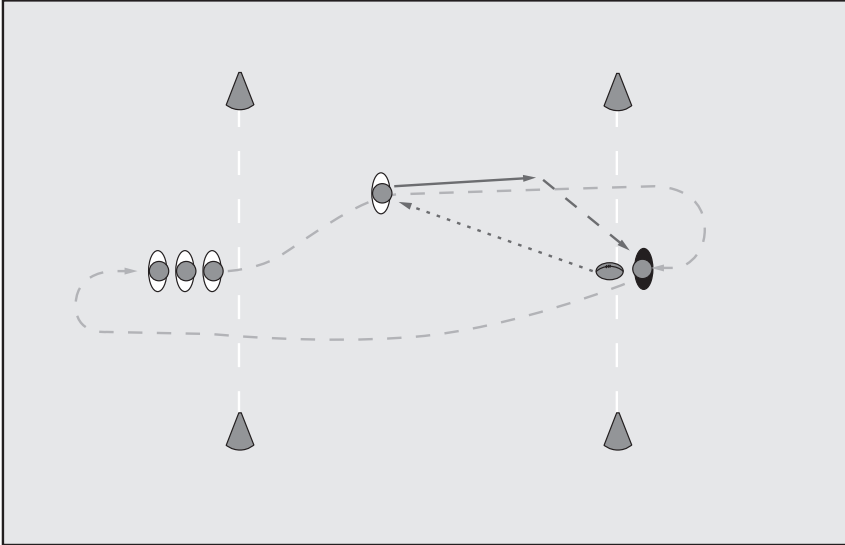

- Equipment: 1 ball per group
- Suitability: Primary School +
- Grid Size: 20 x (10-15)m
- Group Size: 4+

Drill Description:

Another variation to a simple but effective ground drill. Player A is positioned alongside a marker about 15m out from the other players in the group, facing them as in the diagram. Player A rolls the ball towards or to the side of the front Player B in the line opposite who picks up, passes back to Player A and runs to the marker. Player A, after the ball has been returned to him, immediately places it on the ground next to the marker and runs to the end of the line. Player B now rolls the ball for the next player in line.

Variations:

- i) Use two balls and start with two players in possession standing alongside two markers positioned about 1-2 meters apart. This generates more action and players have to use peripheral vision to avoid another player performing the drill. Introduce a third ball and third player if the group size is large.
- ii) The same drill can be converted quite easily into kicking and catching drill – increase the distances involved.

Helpful Hints:

- Balls should be placed firmly with one or two hands depending on the instructions from the coach. Most players can place the ball more safely or at least just as safely with one hand – the two handed technique requires a greater amount of flexibility which a lot of rugby players, especially members of the tight five are a bit short on!
- The ball must NOT be dropped or rolled.
- Players should practice placing the ball on both the left and right sides.

POOR PASSES

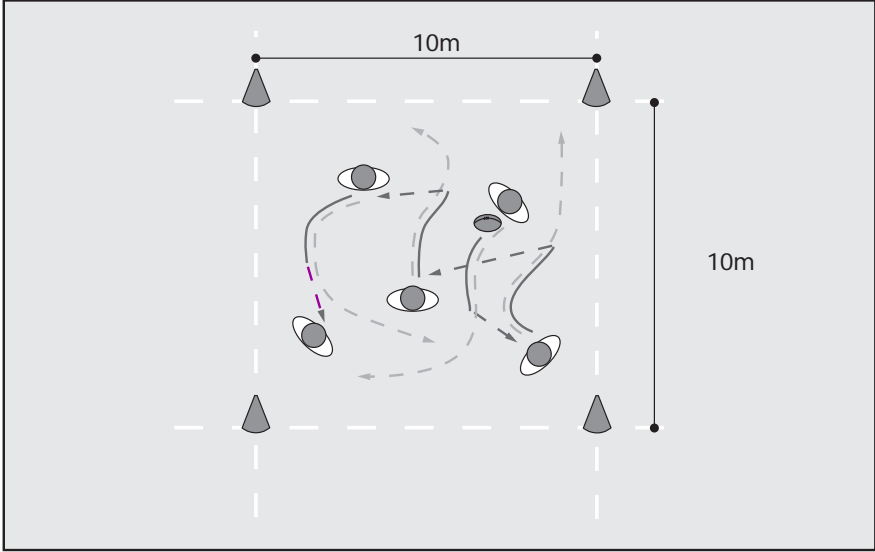

Equipment: 1 ball per group

Grid Size: 10 x 10m

Group Size: 3

Drill Description:

Players work within a grid making poor passes to each other. The aim is to teach players to pick up awkward passes. Passes can be all high, all low, all rolled, all behind, or a combination.

Coaching Points:

- Make sure the players are well stretched before doing this exercise. It not only helps to avoid pulled muscles resulting from sudden movements bending or turning for the ball but increases the success rate by having the players more flexible.
- Players should always have their hands ready and be relaxed.
- Keep eyes on the ball and turn shoulders to receive.
- For low passes players should bend their knees.

UNDER'S + OVER'S

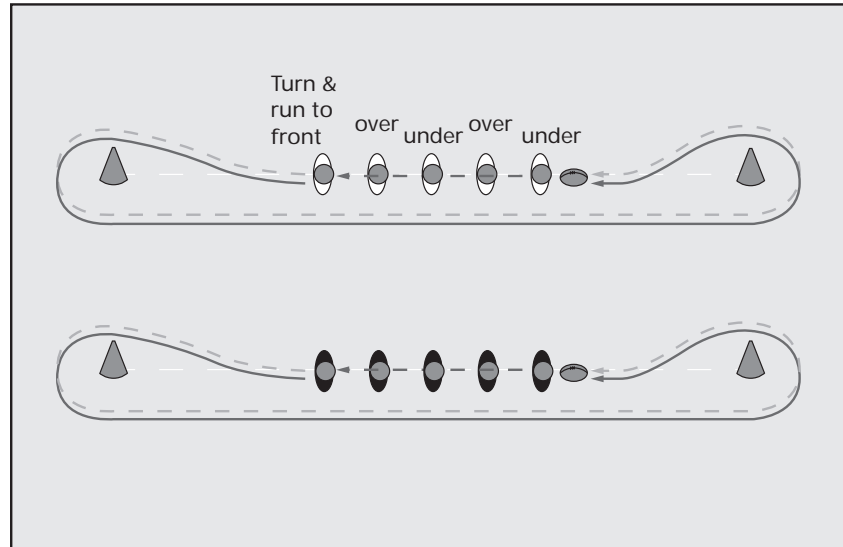

Equipment: 1 ball per group

Grid Size: NA

Group Size: 6 – 8

Drill Description:

Divide players into 2 even teams.

Each team has a ball and the teams are positioned opposite each other in single file with players separated by about one meter. (see diagram).

The front player in each team passes the ball through his legs to the player behind. The second player then transfers to the player behind him by tossing a soft pass over his head and the pattern of passing is repeated until the ball reaches the player at the end.

The last player then runs to front (around the cones as shown) and the exercise continues until the original front player returns to that position.

Advanced: As players skills improve, the distance between the ball carriers can be increased so that the ball carrier has to pass the ball a greater distance between the legs and over the head.

Coaching Points:

- Young players tend to roll the ball along the ground. Ensure the ball is passed between the legs and not rolled.
- Communicate. Young players like to chant "Under..Over..Under..".

CAPTAIN BALL

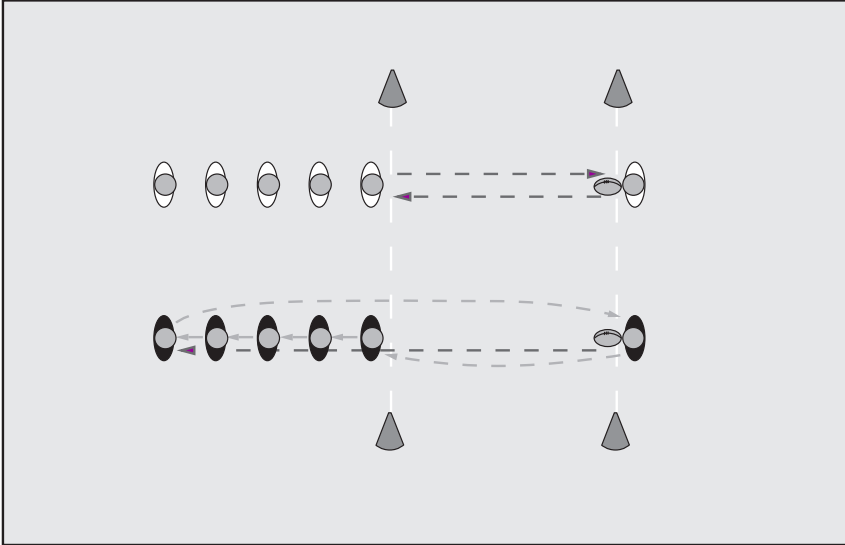

Equipment: 1 ball per group

Grid Size: NA

Group Size: 6 –8

Drill Description:

Team stands in single file 5m away from the “captain” . The captain passes the ball to the 1st player who returns the pass and sits down. The captain passes to each player in turn.

Upon reaching the last player, that person runs to become the captain while the previous captain becomes first in line and the players shuffle back to maintain the distance between the captain and the first player in line. The process is repeated until all have been captain.

Variation:

If dealing with a large group divide into teams and make a game of this drill.

Helpful Hints:

- All passes should be made with players standing side-on so the pass is executed correctly and is not a push or a basketball type transfer.

SPRINT AND POP

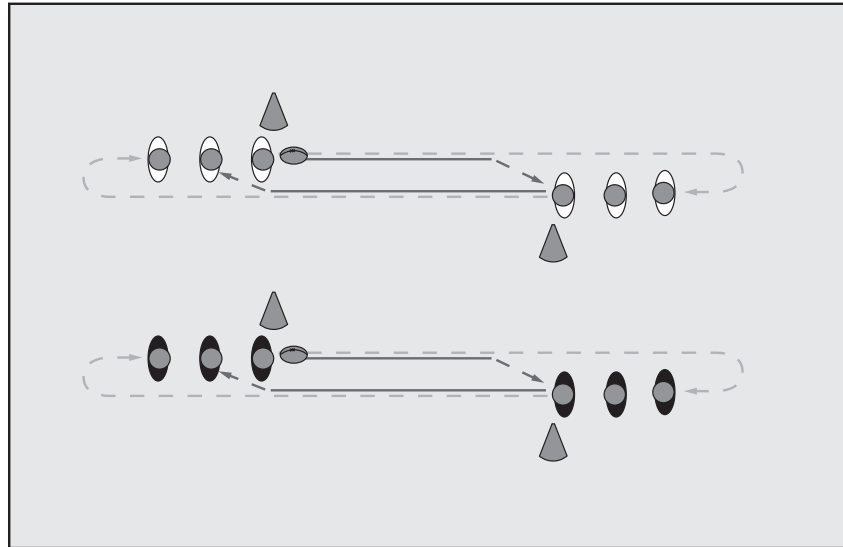

Equipment: 1 ball per team

Grid Size: 20m x 20m

Group Size: 4 – 6

Drill Description:

Divide players into two equal teams. Further divide each team in half with each half lining up in single file at opposite ends of the grid (see diagram).

A player from each team at one end of the grid has a ball. On a call they sprint to the team mate at the opposite end of the grid and pass them the ball, they in turn sprint back etc.

Variation:

Instead of a pass, the ball may be placed at each end or passed one end, placed the other etc.

Helpful Hints:

- The length of the pass is dependant on the skill of the player. Younger players may receive a short, soft pass. Older more skilled players may have a longer pass from a specific point mid- grid.
- Awaiting players should have their hands up.
- When the ball is placed it should be at least 2m out in front of the awaiting players.
- Players should always run with the ball in two hands.

CAPTAIN BALL ROUNDERS

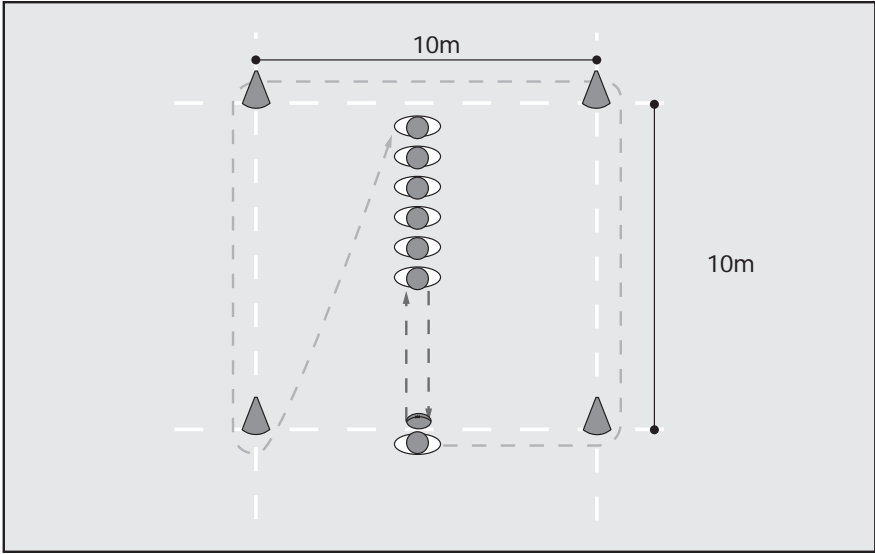

Equipment: 1 ball per team

Grid Size: 10 x 10m

Group Size: 4 – 6

Drill Description:

Divide group into 2 or more even teams then place each team in single file inside a grid (see diagram) with one player out front. Player A gives and receives a pass from team mates B, C, D, E and F. On receiving final pass form F, Player A places ball on ground and runs around the outside of the grid. Meanwhile B moves to the ball, the team members shuffle forward and Player A goes to the back of the line.

The first team back to their original position wins.

Coaching Points:

- Passes can vary in type but basically should be rugby style passes. Coach should designate pass from left/right side and type of pass.

DIAGONAL PASSING

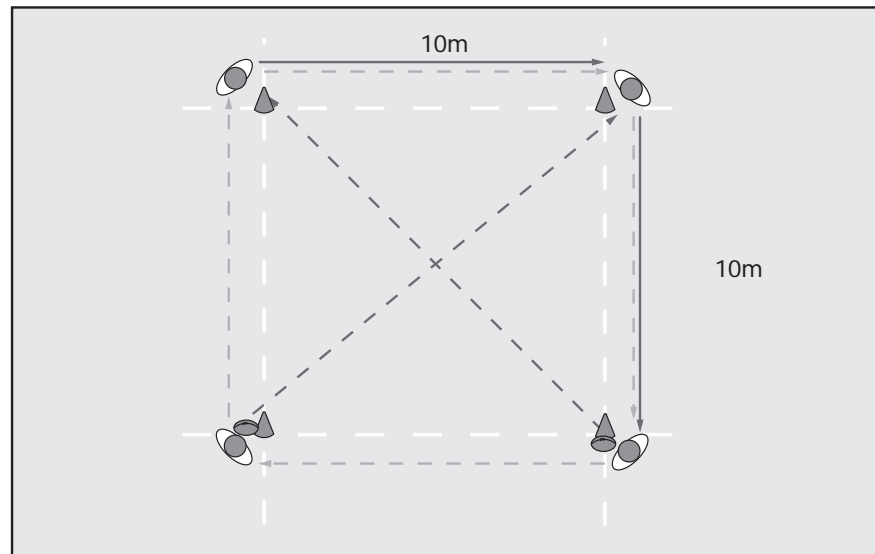

Equipment: 2 balls per group

Grid Size: 10 x 10m

Group Size: 4

Drill Description:

Four players are positioned at the corners of the grid. Two players at adjacent corners have a ball.

The drill begins with all 4 players running in a clockwise direction to the next cone. When the ball carriers reach the next corner they throw a diagonal pass to the non ball carriers and continue on to the next corner. The new ball carriers do likewise and the drill continues. The process continues until the coach call for a change of direction.

Variation:

See how many passes can be made compared to another group. Be sure to pass both left and right by changing the direction of running.

Helpful Hints:

- Passes and receivers should communicate with each other.
- Another drill which lends itself well to competition between groups.

CIRCLE THE WAGON

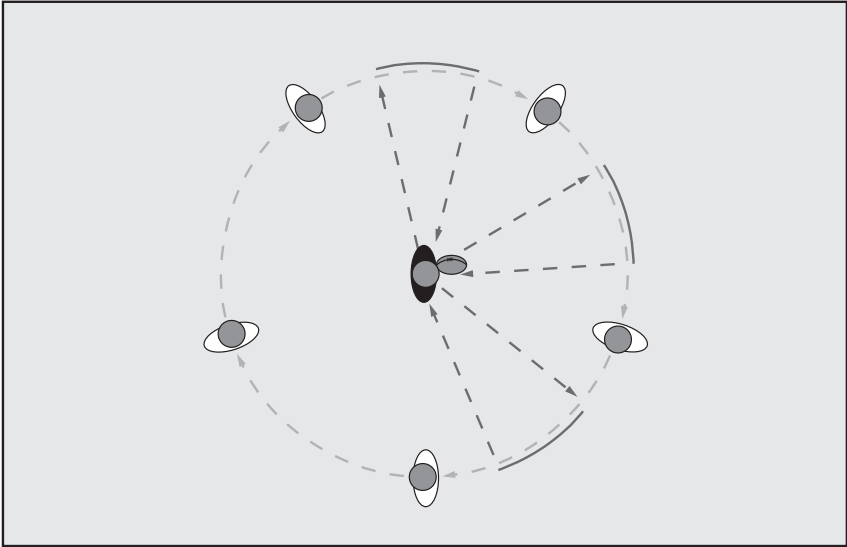

Equipment: 1 ball per group

Grid Size: 10 x 10m

Group Size: 6 – 8

Drill Description:

Players form a circle around a central player. Players in the circle run in the same direction around the central player, who passes to, and receives balls from the players in the circle.

Variations:

- i) The player in the circle who receives the ball passes it over the shoulder to the player behind. This player returns the ball to the central player.
- ii) The player in the circle who receives the ball places the ball on the ground for the player behind to pick up. This player returns the ball to the central player.
- iii) the player in the circle who receives the ball places the ball on the ground for the player to sidestep. The next player picks up the ball and returns it to the central player.
- iv) Have 2 players standing in the middle passing to the outside players.

Helpful Hints:

- Vary the direction of running.
- Vary the player in the middle.
- Instruct the central player to make left side or right side passes or to alternate.
- Pass the ball in front of running player.

HOT POTATO

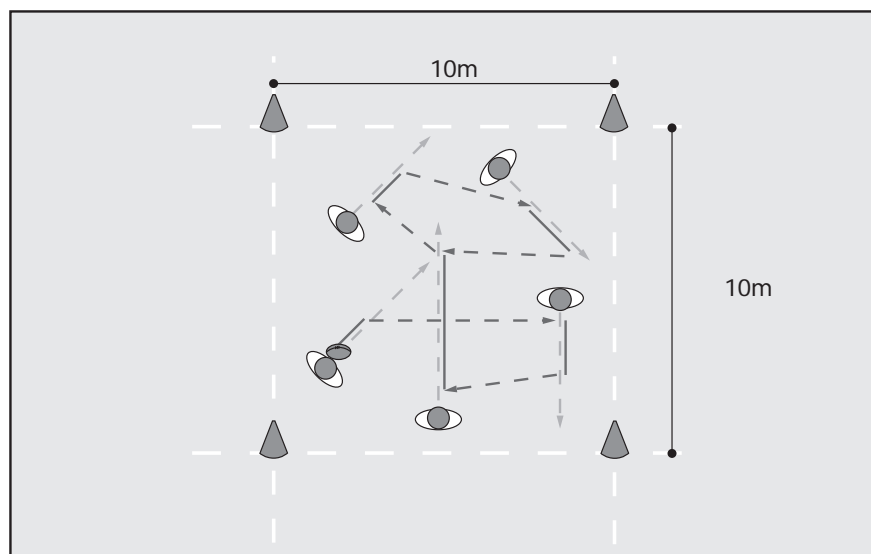

Equipment: 1 ball per group

Grid Size: 10 x 10m

Group Size: 4

Drill Description:

Players run in any direction inside a grid. The player with the ball passes it in front of the receiver. The aim is to complete as many passes as possible within 30/60 seconds.

Variations:

- i) Put 2 groups in one grid each working independently.
- ii) Vary length of pass e.g. all short, all long or 1 short/1 long etc.
- iii) Vary height of pass.
- iv) Alternate passing with placing of ball.
- v) Roll the ball instead of passing
- vi) Grubber kick the ball instead of passing – usually requires a larger grid.

Helpful Hints:

- Players must use all of the grid and not run around in circles or in any sort of repetitive pattern.
- Players should turn shoulders to deliver pass.
- All other players are to have their hands up as targets.
- Players should catch and pass with “soft hands”.
- Passes should not be thrown to people not looking at the passer.
- Passer must nominate the receiver by name before passing.

STEP AND SWERVE

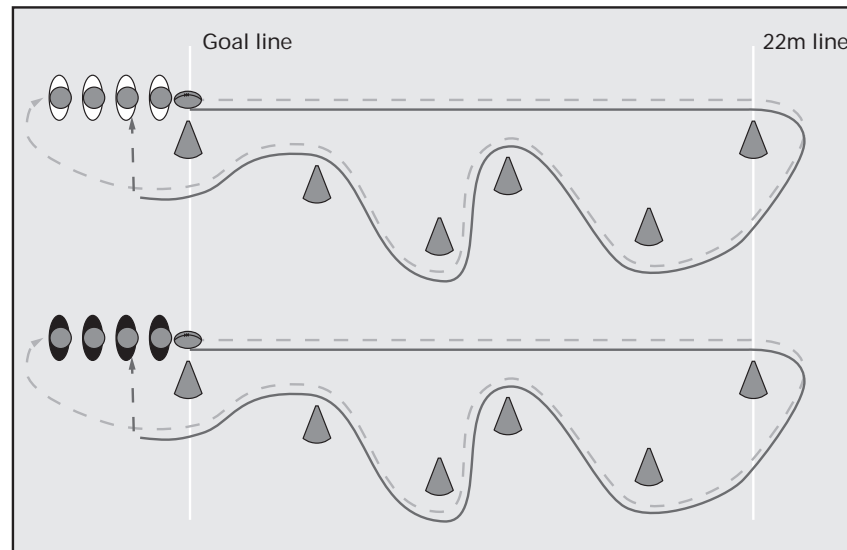

Equipment: 1 ball per group

Grid Size:

Group Size: 3 – 4

Drill Description:

Divide your group into 2 or more even teams and lay out cones in a similar pattern to that shown in the diagram.

The first player in each team does a sprint with the ball in two hands over the straight 22m opening the leg of the running course. He returns to the starting point swerving at pace around the cones while transferring the ball to the outside arm as he negotiates each of the markers.

Coaching Points:

- The player should “feint” and then “swing away” when executing the swerve.

OUT + BACK

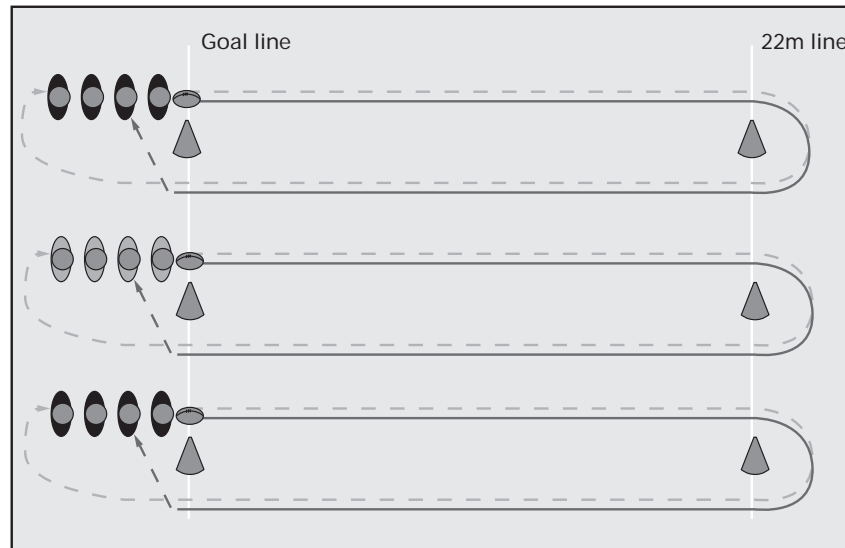

Equipment: 1 ball per group

Suitability: Primary School +

Grid Size: 20m channel

Group Size: 6 – 15

Drill Description:

Divide your group into 3 or more even teams, each team facing a marker 15m or so away (see diagram).

Each of the front players has a ball and runs around the marker, performing a designated skill, before returning to their line handing the ball to the next player.

Skills used could be:

Lap 1: roll ball and pick up on way out and back.

Lap 2: dribble ball along ground.

Lap 3: rotate ball around trunk twice on way out and also on the way back.

Lap 4: chip kick, chase and catch on way out. Sprint back.

Lap 5: shoulder roll at start and after rounding cone – ball in arms.

Helpful Hints:

- When picking up rolling ball, the players should lower his body well before the pick up, bend the legs and scoop through with back hand.
- When dribbling, players should use only short kicks and keep ball in control. Dribble the ball with the instep of each foot.

RUGBY BASEBALL

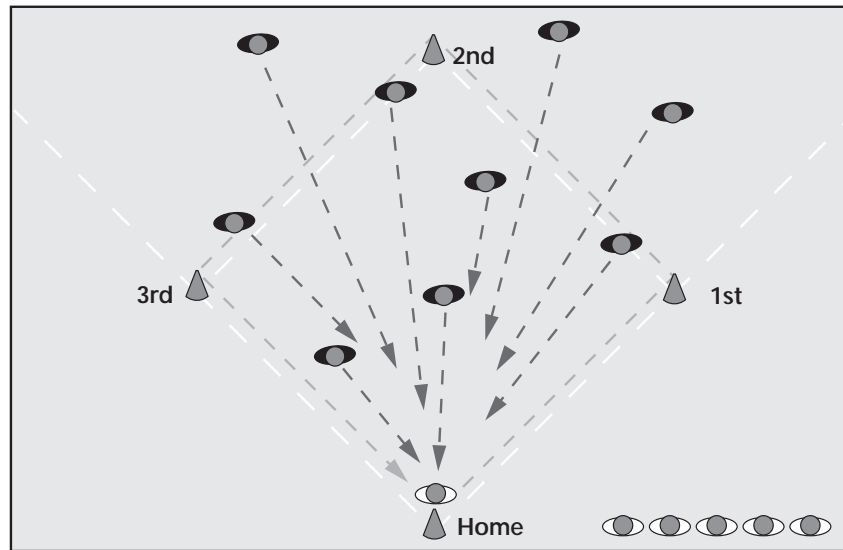

B) Passing Baseball

Group Size: divide the class into two equal teams

Equipment: four markers
one ball

Grid Size: 15 x 15m square

Description

- i) the fielding team scatters around the field;
- ii) the batting team passes the ball within the area bounded by the first and third bases;
- iii) after the ball is passed, the fielding team must string together five passes before returning it to the base;
- iv) the batter has to run as many bases as they can before the fielders make their five passes;
- v) if the ball beats the player to the base, then they are out – three out, all out.

Variations

- everyone on the fielding team has to touch the ball before it returns to base
- increase or decrease the size of the playing area
- introduce a time limit on getting the ball back to base
- let everyone in the team bat and count how many home runs each team gets

Skills involved

- catching and passing
- team work
- team communication
- team position awareness
- finding and using spaces/gaps

C) Kicking Baseball

Group Size: Divide the class into two equal teams.

Equipment: Four markers
One ball

Grid Size: 15 x 15m square

Description

- i) the feeding team scatters around the field;
- ii) the batting team kicks the ball within the area bounded by the first and third base;
- iii) after the ball is kicked, they must then attempt to run around all the bases before returning to home base;
- iv) if the ball beats the player back to base they are then 'out';
- v) if the ball is caught by a fielder on the full the player is also out;
- vi) when three players become 'out' their whole team is out and the batters then become fielders.

Variations

- everyone on the fielding team has to touch the ball before it returns to base.
- Increase or decrease the size of the playing area.
- Introduce a time limit on getting the ball back to base.
- Let everyone in the team bat and count how many home runs each team gets.

Skills involved

- Catching and passing
- Kicking
- Team work
- Team communication
- Team position awareness
- Finding and using space/gaps

Teacher Questions

What was the most effective way of getting the ball back to the bases?

What should you do when a ball is kicked/passed to you?

RUGBY TENNIS

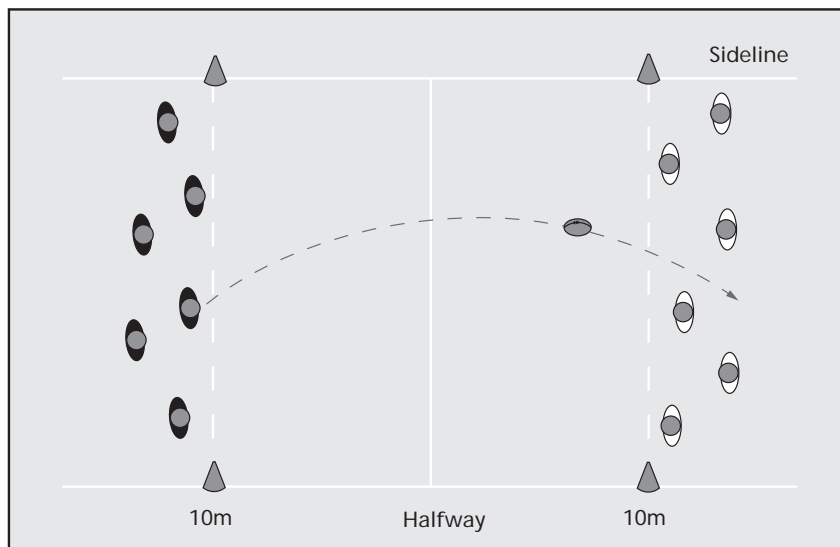

a) Passing Tennis

Group Size: divide the class into two teams

Equipment: one ball
markers

Grid Size: between the 22 and side lines

Descriptions

- i) the two teams proceed to pass the ball over a centre line to each other;
- ii) the teams must try and catch the ball as it comes over the centre line;
- iii) if the ball is dropped, a point goes to the other team;
- iv) the ball has to pass above waist height, if not, a point is awarded to the other team;
- v) if the ball drops between players, a point is also incurred;
- vi) the first team that reaches a nominated score wins and then the teams are changed.

Variations

- incorporate a certain number of passes before passing
- if the ball is dropped players become eliminated
- use kicking instead of passing

Skills involved

- catching
- passing
- spacial awareness
- team communication

Teacher Questions

Why does the ball have to cross the line at waist level?

Why is it good to pass the ball between players before passing it back over the line?

B) Kicking

Group Size: Divide the class into two equal teams

Equipment: One ball
Markers

Grid Size: between the 22 and sideline

Description

- i) the two teams proceed to kick the ball over a centre line to each other;
- ii) the teams must try and catch the ball as it comes over the centre line;
- iii) if the ball is dropped a point goes to the other team;
- iv) the ball has to pass above waist height. If not a point is awarded to the other team;
- v) if the ball drops between players a point is also incurred;
- vi) the first team that reaches a nominated score wins and you change teams.

Variations

- incorporate a certain amount of passes before kicking
- if the ball is dropped the player is eliminated
- use passing instead of kicking

Skills involved

- catching
- kicking
- spacial awareness
- team communication